

# Drive Away Protection System (EWS)

**Model: EWS I/EWS II/EWS III/EWS III D  
E31/E34/E36/E38/E39/E46/E52/E53**

**Production Date: All since 1/94**

## **Objectives**

After completion of this module you should be able to:

- Explain the differences in the EWS systems.
- List the components that make up the different EWS systems.
- Describe the operation of each system.
- Understand and relate the data exchange sequence between the EWS and DME.

## **Drive Away Protection**

The first version of Drive Away Protection was installed on production vehicles **9/93 through 12/93**.

### **Purpose of The System**

The purpose of the Drive Away Protection system was to reduce vehicle theft as mandated by the European Insurance Commission to combat the high theft rate in European Countries.

This first version of the Drive Away Protection System added a circuit from the General Module to the DME. The added circuit was spliced into the existing code function from the Board Computer (BC) to the DME.

The components of the Drive Away Protection System are:

- Door Lock Switch
- General Module
- Board Computer
- DME

### **System Components**

#### **Door Lock Switch**

The door lock switch provides a 12V (High) signal to the GM when the vehicle is locked from the outside. The switch also provides a Low signal to the GM when the vehicle is unlocked.

#### **General Module**

The GM receives the lock and unlock signals from the door lock switch and signals the DME with a 12V High signal when the vehicle is double locked or with a Low signal when this vehicle is unlocked.

#### **Board Computer**

The Board Computer (BC) through its' code function provides a High signal to the DME to disallow vehicle operation or a Low signal to allow vehicle operation.

#### **DME**

The DME looks for a High/Low signal from the BC or GM and dependent on the signal, it will either allow or prevent vehicle operation.

## Principle of Operation

When the vehicle is locked from the outside, a High signal is sent to the GM from the door lock switch. The GM receives this High signal and outputs a High signal to the DME. The circuit from the GM is spliced into an existing circuit from the BC to the DME.

A High signal from the GM (or BC) causes the DME to cancel the fuel and spark functions to the engine resulting in a no-start condition. The vehicle must be unlocked with the key or the code function of the BC cancelled for the DME to allow engine operation.

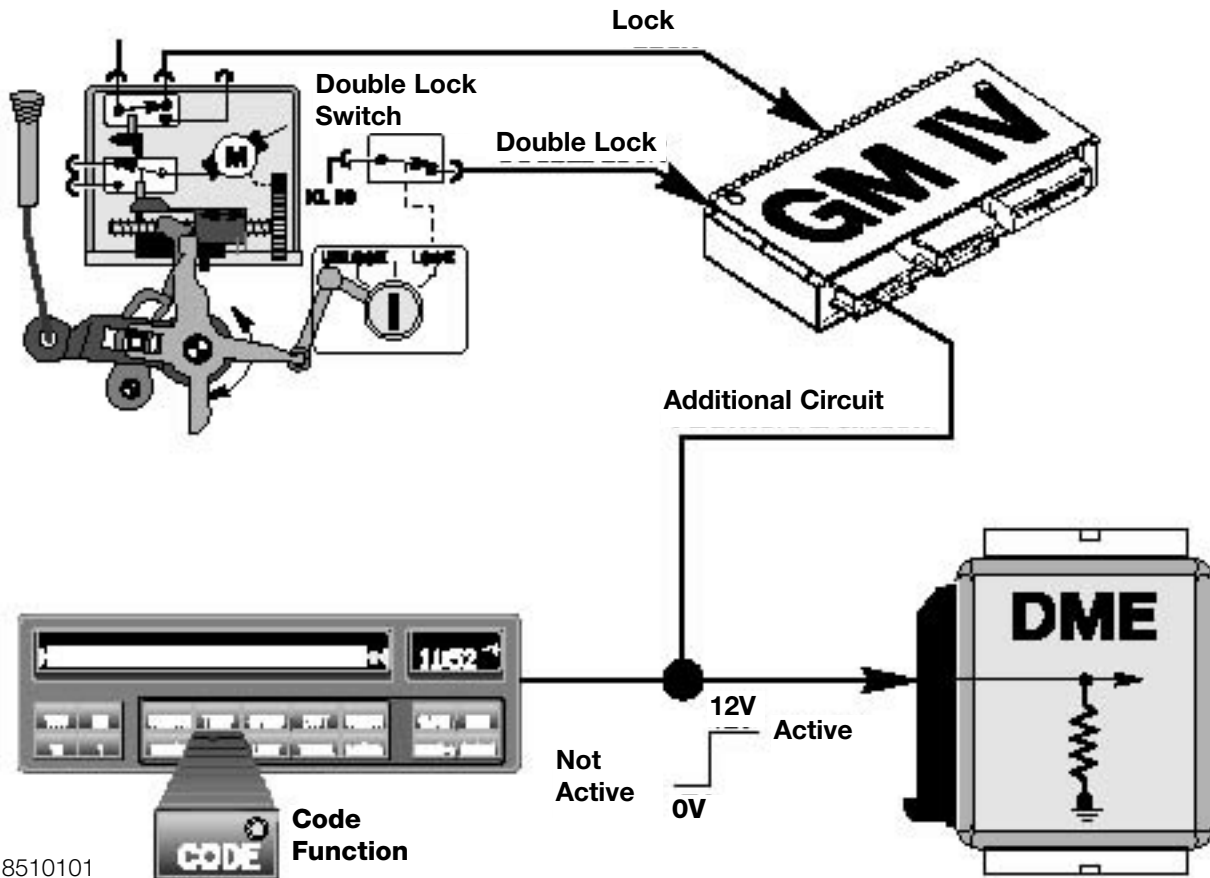

8510101

The status pages of the ZKE and DME will show the condition of the Drive Away Protection signal as High/Active or Low/Not Active.

# EWS I

EWS I was installed on vehicles beginning production **1/94**, replacing the original Drive Away Protection System.

## Purpose of the System

The next level of compliancy with the European Insurance Commission required additional changes from the previous system. An additional component was added called the **Starter Immobilization Relay**. This relay module provides added theft prevention and safety features.

At the time of introduction the system was referred to as **Electronic Drive Away Protection** which in German is ***Electronische Wegfahrsperre*** or EWS.

The EWS I system consisted of the following components:

- Starter Immobilization Relay
- Door Lock Cylinders and Switch
- General Module
- Board Computer (if equipped)
- Transmission Range Switch
- DME Engine Speed Signal (Beginning 6/94 Production)
- DWA (E31)

## System Components

### Starter Immobilization Relay

The Starter Immobilization Relay was installed on E31, E34 and E36 vehicles. It was in the following location:

**E36** -In the relay carrier to the left of the steering column.

**E31/E34** -In the “A” pillar above the footwell kick panel speaker.

The Starter Immobilization Relay functions as a “Smart Relay”, a relay which receives inputs from various sources looking at the proper combination of input signals before activating a component, in this case the starter.

The Starter Immobilization Relay receives input from:

- Ignition Switch
- General Module
- Board Computer
- Trans Range Switch
- DME (>6/94)

And processes output to:

- Starter
- DME



8510104

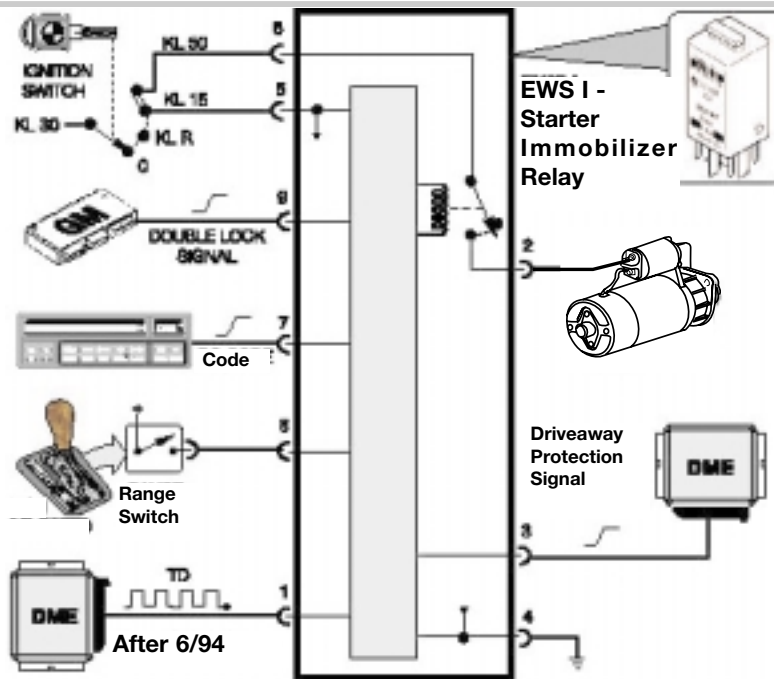

8510103

## Door Lock Cylinders and Switch

The door lock cylinders and switch input a High/Low signal into the GM informing the GM of lock status. The signal is High when the system is in Double Lock.

## General Module

The GM receives the High/Low signal from the door lock switch and outputs a High/Low signal to the Starter Immobilization Relay. A High signal indicates the vehicle is in Double Lock.

## Board Computer

The Board Computer outputs a High/Low signal to the Starter Immobilization Relay. A High signal indicates the Code function is active.

## Transmission Range Switch

The Transmission Range Switch input with automatic transmission equipped vehicles allows the Starter Immobilization Relay to provide a Neutral safety switch function. A High signal from the Trans range switch indicates the transmission is in Park or Neutral. A Low signal indicates the transmission is in a drive gear and will prevent starter operation.

## DME

The DME is both an input device (after 6/94) and an output device of the Starter Immobilization Relay.

## Input

Starting with production 6/94, the DME "TD" (engine speed) signal was added to the inputs of the Starter Immobilization Relay. This additional input allows the relay to provide a starter protection feature. The internal relay contact (starter operation) opens if the TD signal exceeds 60 Hz which equals the following engine speeds:

- 4 cylinder =1800 RPM
- 6 or 12 cylinder =1200 RPM
- 8 cylinder =900 RPM

The relay contacts will close when the exceeded Hz value drops to 5Hz below the maximum value. This is intended as a safety feature to prevent starter motor activation when the engine is running above these speeds.

### **Output**

The DME receives a High/Low signal from the Starter Immobilization Relay. When the signal is High, the DME does not activate injector or ignition operation.

### **DWA (E31)**

The DWA outputs a High/Low signal to the Starter Immobilization Relay indicating the condition of the alarm system. A High signal indicates the alarm is armed, preventing vehicle starting.

## **Principle of Operation**

The EWS Starter Immobilization Relay receives it's inputs from the Ignition switch, GM (or DWA), BC, Trans Range Switch and the DME (after 6/94). The relay will prevent engine starting if:

- The vehicle is locked from the outside. The GM receives the High signal from the door lock switch and sends a High signal to the EWS.
- The BC Code function is set.
- A DWA High signal is received. (E31 only)
- A Low signal is received from the Trans Range Switch.
- The engine speed signal from the DME exceeds 60Hz. (after 6/94)

The Ignition and injection functions of the DME are disabled and the KL50 start signal to the starter is opened to prevent starter operation.

### **Workshop Hints:**

Starter Immobilization Relays are different for manual and automatic vehicles, check to ensure correct relay is installed.

The Starter Immobilization Relay is not on the Diagnostic Link. Conventional troubleshooting techniques using the DISplus, a DVOM and the correct ETM are necessary.

Loss of input from the GM or BC will allow the engine to start.

Loss of input from the Trans Range Switch will **NOT** allow the engine to start.

## EWS II

Starting with **1/95** production, all vehicles were equipped with a new EWS system, EWS II. This change was once again brought about to meet the next level of compliancy with the European Insurance Commission regulations.

### Purpose of The System

Changes to the European Insurance Commission regulations made it necessary to introduce a new theft protection system with greater capabilities and a higher level of security. The EWS II system operates independent of the mechanical key. The mechanical key only makes a request of the vehicle starting system. Verification of the key electronically is required before the starting procedure is initiated.

The system features wireless communication between a programmed EEPROM housed in the ignition key and the EWS II control module. A key which is properly coded to the EWS II control module is required before starting operation continues. The EWS II and the DME control modules are synchronized through an Individual Serial Number (ISN).

The ISN, stored in the EWS II, must match that of the DME every time the ignition is switched "ON" before engine operation is allowed.

EWS II was installed on E31, E34, E36, E38 and E39 vehicles.

Major components of the EWS II system are:

- Key with Transponder
- Ring Antenna
- Transmitter/Receiver Module
- EWS II Control Module
- DME Control Module

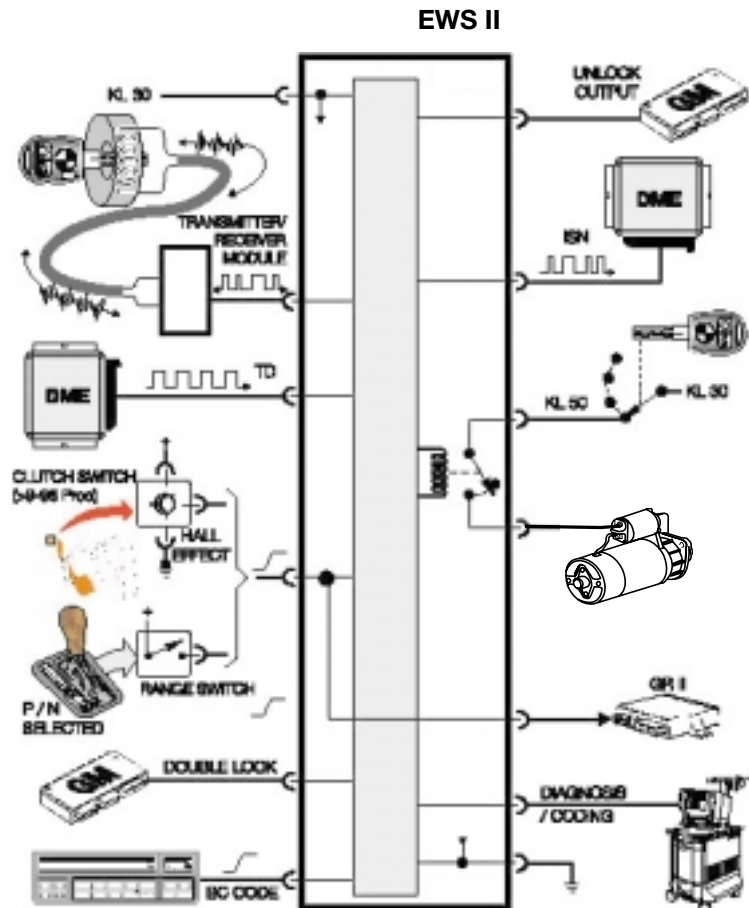

# System Components

## Key with Transponder

Four keys are initially supplied with each vehicle. Each key contains a wireless electronic chip (transponder chip). The function of the transponder is to receive and transmit data to the EWS II control module. The transponder contains a wireless read/write EEPROM in addition to a small capacitor and coil for self power capabilities.

The functions of the EEPROM are:

- Store codes for key identification, password and changing codes.
- Receive and respond to coded messages from the EWS II control module.

Power for the transponder is produced through the inductive coil and stored in the capacitor. Each time the key is inserted into the ignition AC voltage in the antenna ring induces voltage in the inductive coil.

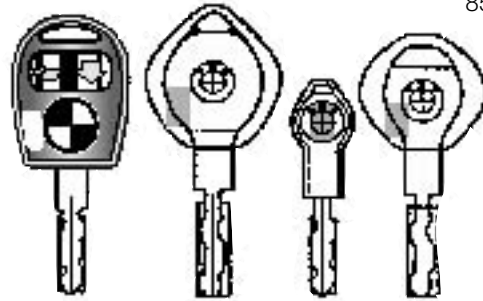

8510107

All keys either with remote or without, including wallet and valet keys contain transponders.

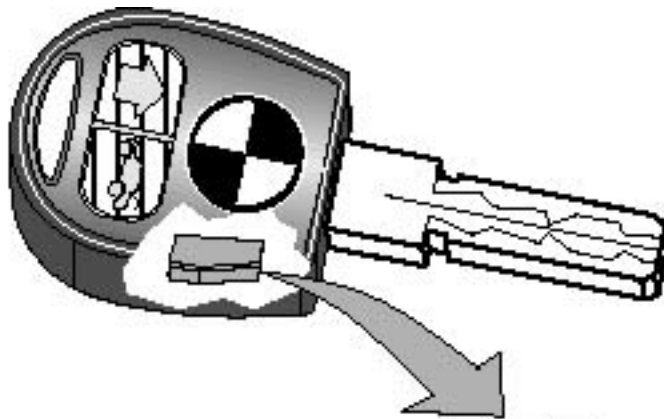

### Key Notes:

Keys have temperature operating range of  $-40^{\circ}$  to  $80^{\circ}\text{C}$ .

Keys are shock resistant from a height of 10 meters.

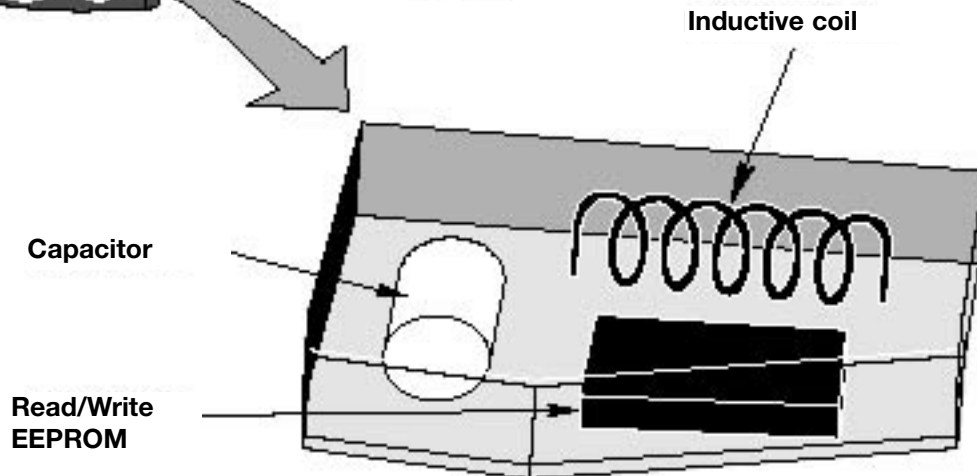



## Ring Antenna

The Ring Antenna is an inductive coil installed around the lock cylinder which provides power for the transponder in the key and the communication link (antenna) between the key and the transmit/receive module.

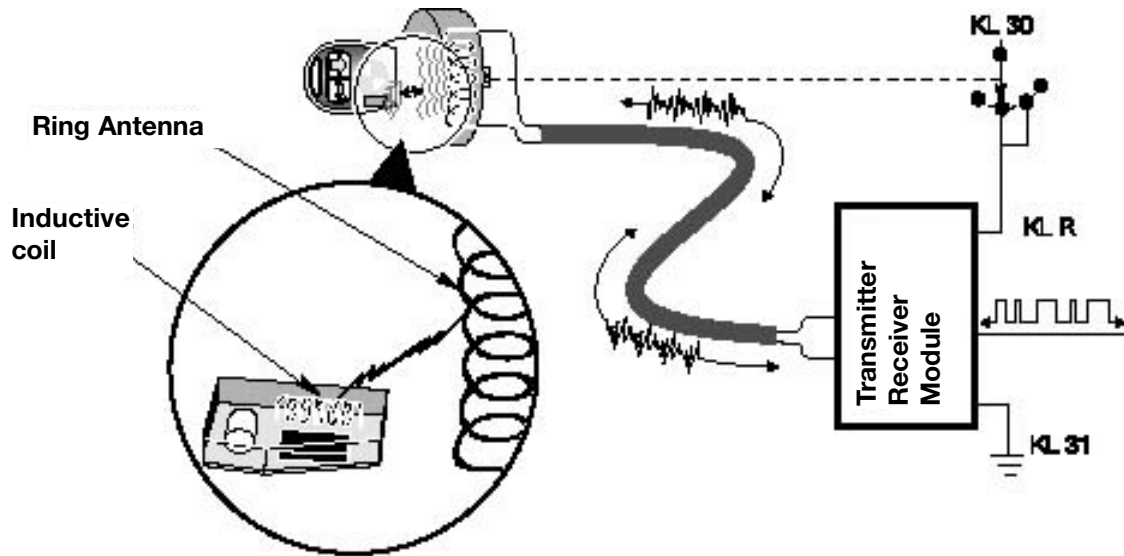

8510109

## Transmitter/Receiver Module

The Transmitter/Receiver module supplies power to the transponder through the ring antenna and controls the flow of data between the transponder and the EWS II control module.

Data transmission between the transmitter/receiver module and the transponder takes place over a radio frequency of 125 KHz amplitude modulated AM signal.

The transmitter/receiver module converts the analog data received through the AM signal to digital data and transfers it to the EWS II control module over a single wire bi-directional data interface.

### Workshop Hint:

On E34 and E36 models the transmitter/receiver module is located under the dash near the steering column.

On E 31, E38 and E39 models the transmitter/receiver module is located in the steering column cover on the right hand side of the column.

### Transmitter/Receiver Module under Dash

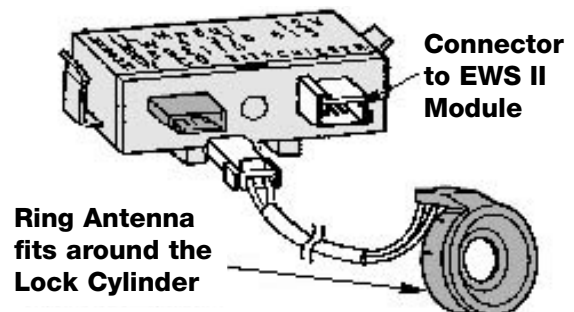

8510110

## EWS II Control Module

The EWS II Control Module is linked to the BC, GM, DME, Trans Range switch and the starter for drive away protection operation. The module incorporates an integral starter relay and stores data and codes for communication with the transponder chip.

The function of the EWS II module is to provide improved drive away protection for the vehicle and it incorporates many features of previous systems:

- Lock out of the starter when the code function of the BC is set.
- Disable injection and ignition through the DME.
- Prevent starter engagement with engine running.
- Recognition of Park/Neutral position with automatic transmission.

New features that have been added:

- Disable injection, ignition and starter operation until a correct key is recognized.
- EWS and DME synchronization through the use of the ISN.
- Release of double lock when a correctly coded key is switched on.

The EWS II control module stores the following data for the key transponder inter-link:

- Key identification code- up to 10 keys.
- Key password.
- Changing code- up to 10 keys.

### Workshop Hint:

On E31, E36, E38 and E39 models the EWS II control module is located behind the glove box in the electrical carrier.

On E34 models the module is located on the drivers side of the vehicle behind the knee bolster.

### Typical component locations E36 shown

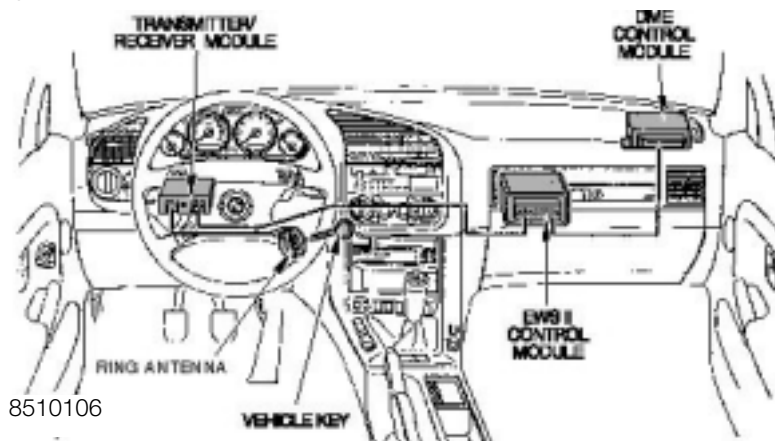

8510106

## DME

The DME is redesigned to incorporate the new ISN code. As of production 1/95 all DME control modules will contain the unique ISN number and will not interchange with previous DME's. The following new features are added to the DME:

- Unique ISN assigned to DME during manufacture, it can not be changed, altered or overwritten.
- The BC code input to the DME is eliminated.
- The DME and EWS II control module must be synchronized. The DME sends the ISN to the EWS II module which stores the number for replay to the DME.
- The ISN received from the EWS II module during start-up is compared to the internal ISN of the DME. The numbers must match before the start operation is allowed to continue.
- The ISN is sent to the DME continuously by the EWS II module with the key on.
- The DME will ignore loss of the ISN after the engine is running.
- The DME retains the ISN information from the EWS II module for 10 seconds after the ignition is switched off.

*Restarting or switching the ignition on within the 10 seconds cancels the key identification process.*

### Workshop Hints:

The DME is located in the E-Box.

Remember the EWS-DME link stays active for 10 seconds while testing keys for proper operation.

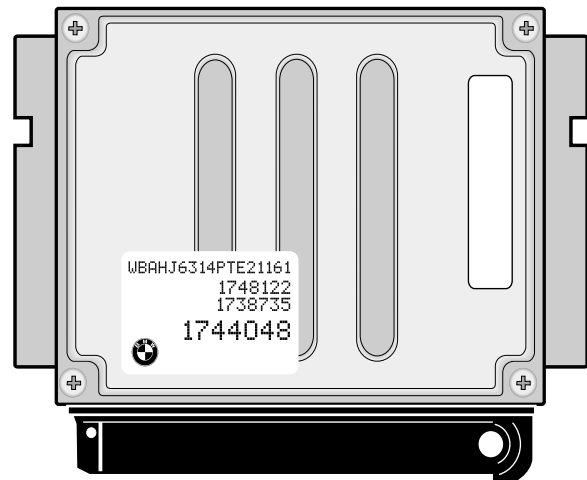

# Principle of Operation

The starting sequence involves communication between all the components of the system. Any break-down in the communication process will result in a no start condition. The sequence of events for vehicle starting is as follows:

- The key is inserted into the lock cylinder and switched “ON”. The transmitter/receiver module is powered through KL R. The transmitter/receiver module sends a 125kHz. AM signal to the ring antenna. The AM signal induces voltage in the key coil and powers up the transponder.
- Powered up, the key transponder sends the key identification code to the transmitter/receiver module via the 125kHz AM signal (1). The transmitter/receiver module converts the AM signal to a digital signal and sends it to the EWS II control module (2).
- The EWS II control module verifies the key identification code and checks to see if the key is enabled (3).

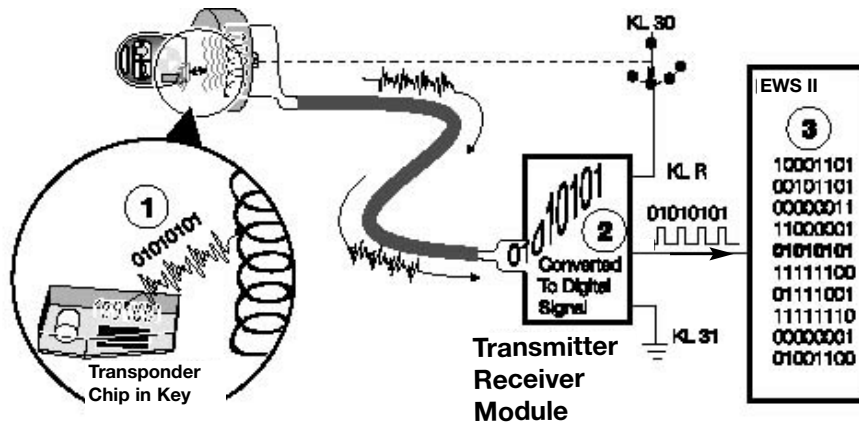

8510120

- Upon accepting the key as valid and enabled the EWS II control module sends a digital password (4) to the transmitter/receiver module, which converts the data to an AM signal (5) and sends it to the transponder via the ring antenna (6).

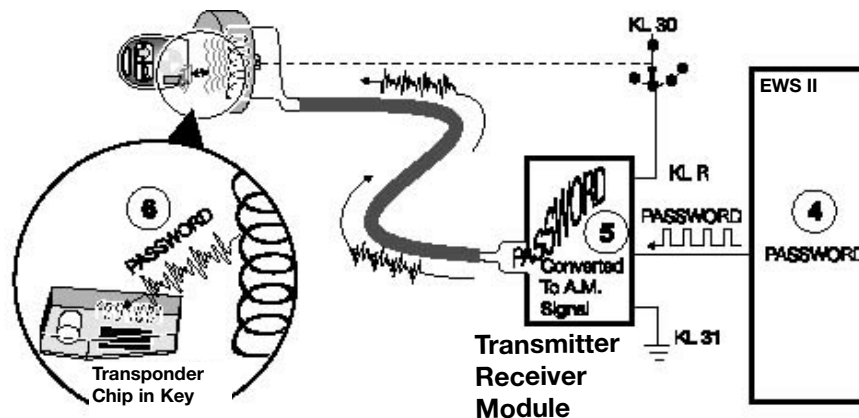

8510121

- If the transponder accepts the password as correct the transponder releases the changing code (7) to the transmitter/receiver module which converts this AM signal to digital (8) and sends it to the EWS II module (9).
- If the changing code received by the EWS II module is correct, the status of the BC, transmission range switch and TD is examined. With correct input status the internal starter relay is energized and the starter motor begins to operate (10). At the same time the EWS II module sends the ISN to the DME via the single wire communication link (11).
- If the ISN code stored in the EWS II module matches that of the DME, the drive away protection is cancelled and injection and ignition is enabled.
- During the process of sending the ISN to the DME, the EWS II module sends a new changing code to the transponder through the transmitter and ring antenna.

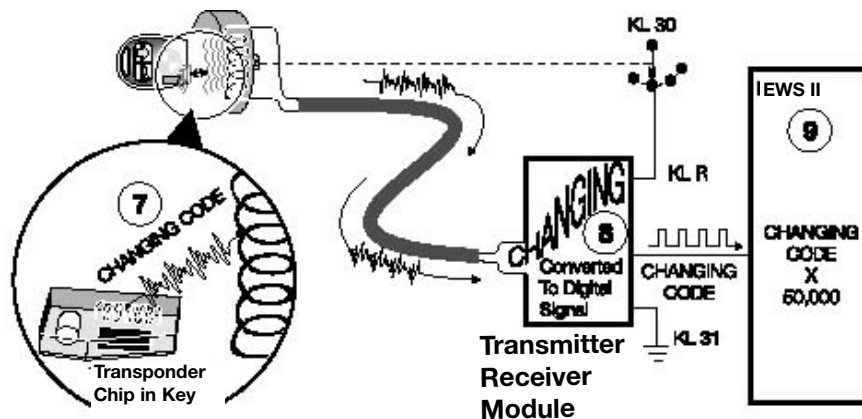

8510122

The transponder stores the changing code until the next starting sequence.

#### Workshop Hints:

The entire process takes place in under 750ms.

If the starter operates, the key has been recognized as OK and the key requires no further diagnosis. Check status of ISN in DISplus or MoDic.

Recognition of a valid key by the EWS II module causes it to send an unlock signal to the GM if the vehicle is in double lock.

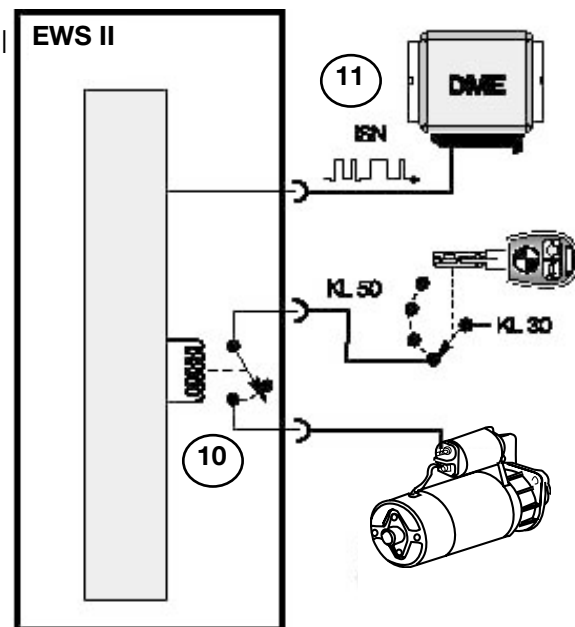

8510124

# Replacement Procedures

## Keys

Up to 6 additional keys may be ordered as replacement keys. The EWS II control module is codeable for only 10 keys (4 delivered with vehicle and 6 replacement).

## EWS II Control Module

Replacement EWS II Control Modules must be ordered VIN specific. EWS II modules contain the VIN and coding from the factory to recognize the key codes. Modules from other vehicles will not recognize keys as being valid and not start the engine.

EWS II Control Modules store the Central Coding Key (ZCS) and the VIN. If the EWS II control module is replaced the system must be ZCS coded (**SIB 61 02 96 and TRI 61 01 95**).

The EWS II module must be synchronized with the DME (aligned). There is no limit to the number of times the ISN may be changed in the EWS II module.

## DME Control Module

The DME Control Module is not ordered VIN specific and must be programmed during replacement. The ISN from the new DME must be transferred to the EWS II module using the DISplus or MoDic.

## Key Activation

Keys that are lost or stolen may be deactivated or made to not operate the starter functions. The SERVICE FUNCTIONS of the DISplus or MoDic for EWS II contains a “Bar/Release Code” function that activates and deactivates keys of the EWS II. Any key may be “Barred” except the key in the ignition at the time of deactivation. The lost or stolen key can be identified by the identification of the remaining keys.

There is no limit to the number of times a key can be activated/deactivated.

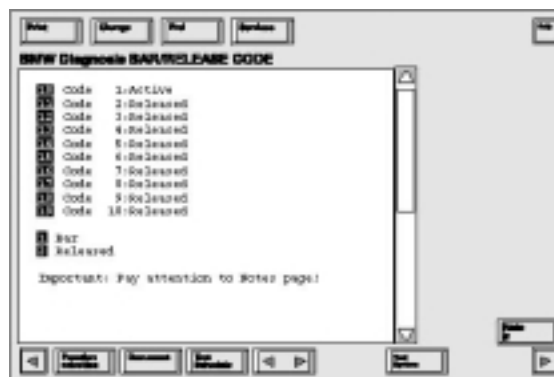

**Note:** A “Barred” key will not start the engine, it will still *unlock* the vehicle.

## EWS II Update

Beginning MY 1997 E31 and E36 vehicles with manual transmissions were updated to include a clutch pedal position switch. The clutch switch signal is provided by a hall-effect sensor providing a high signal when the clutch is depressed.

## **EWS III (3.2)**

The **1997 Model Year E38** is equipped with EWS III (3.2) drive away protection. **E39** vehicles produced **3/97** and later are also equipped with EWS III (3.2).

### **Purpose of the System**

The major changes of the EWS III (3.2) system over the EWS II are a modified control module, revised wiring and the addition of the clutch switch input.

Output functions, starter control and ISN signal, remain the same for EWS III (3.2). Component changes are:

- EWS III (3.2) Control Module.
- Input From The K-Bus.
- Clutch Switch.
- Transmitter/Receiver Module Eliminated.

### **System Components**

#### **EWS III (3.2) Control Module**

The EWS III (3.2) Control Module has a 13 pin connector. The transmitter/receiver module is no longer a separate module of the system with the electronic functions for the data transfer between the key transponder and the EWS control module being handled directly by the EWS III (3.2) control module. The vehicle wiring harness has been changed to reflect this modification and to route the wiring from the ring antenna directly to the EWS III (3.2) control module.

#### **Input From The K-Bus**

Reduction in wiring has also been accomplished with the use of the K-Bus for data communication between the GM, Door Module, IKE and the EWS III (3.2) control module. This data link provides the following signals to be communicated on one wire:

- Engine Speed.
- Lock and Unlock Requests.
- Code Function.
- Range Selector Position (Redundant Signal).

#### **Engine Speed**

The DME outputs the engine speed "TD" signal over the CAN Bus to the IKE. The IKE uses the TD information as needed and passes it on to the EWS III (3.2) via the K-Bus.

## Lock and Unlock Requests

The lock and unlock information arrives at the GM over the P-Bus from the door module and is sent via the K-Bus to the EWS III (3.2) control module. This information informs the EWS control module the lock status of the vehicle (lock/double lock). The EWS III (3.2) control module signals the GM over the K-Bus that an authorized key has been recognized and requests the doors be removed from the double lock position.

## Code Function

The code function status arrives at the EWS control module over the K-Bus. This information allows/disallows vehicle operation based on code status. If a code has been set and entered correctly during the start-up, the vehicle will operate normally based on the other inputs. Entering the code incorrectly will prevent vehicle operation.

## Range Selector Position

Range selector position is still provided directly to the EWS III (3.2) control module from the Transmission Range Selector Switch. Redundant information is provided over the K-Bus in case of loss of signal from the range switch.

### Workshop Hint:

If the starter engages the following inputs are functioning normally:

- Key
- Code Function
- Trans Range (Clutch Switch)
- Engine Speed

Don't waste time diagnosing these inputs.

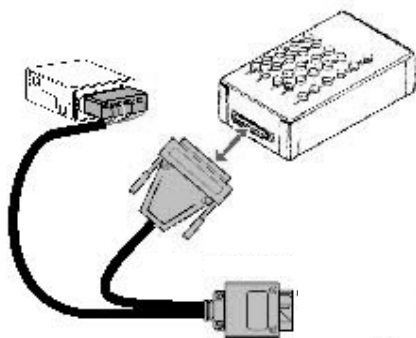

13 pin cable adapter P/N 61 3 190 for EWS III (3.2) diagnosis.

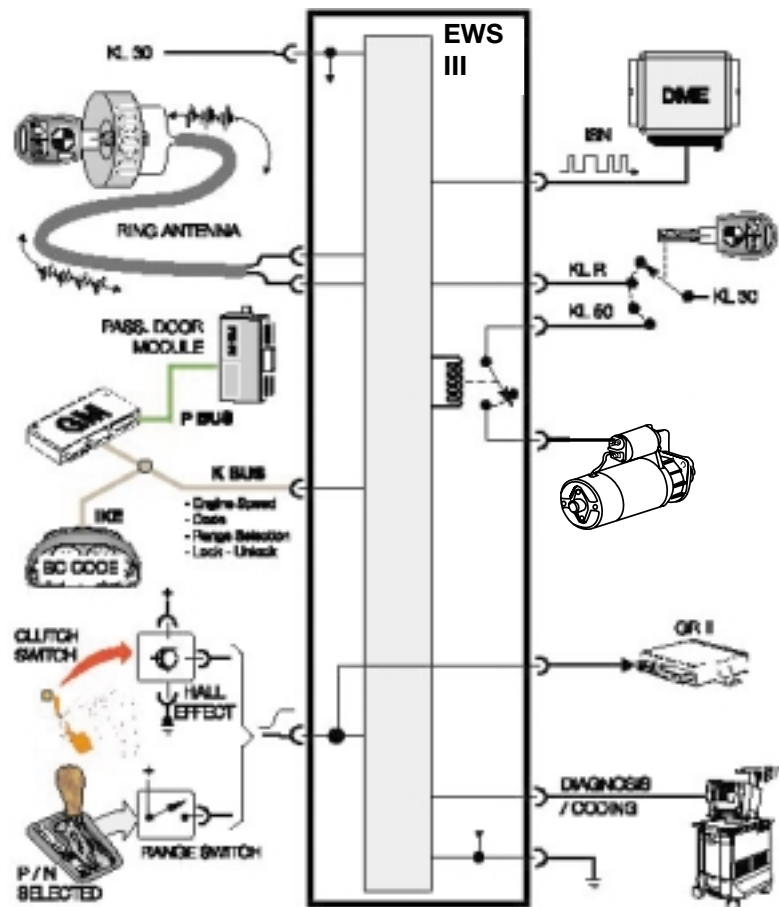



## **Clutch Switch**

A Hall-Effect Switch is added to the clutch system to inform the EWS III (3.2) control module of clutch status. Input from the switch replaces the signal from the Trans Range Selector Switch on manual transmission equipped vehicles. High signal status indicates the clutch is depressed and vehicle starting is allowed.

## **Principle of Operation**

The starting sequence for the EWS III (3.2) is as follows:

- The key is inserted into the lock cylinder and switched “ON”. The EWS III control module is powered through KL R and sends a 125kHz AM signal to the ring antenna. The AM signal induces voltage in the key coil and powers up the transponder.
- Powered up, the key transponder sends the key identification code to the EWS III module. The EWS III module verifies the key identification code and checks to see if the key is enabled. If the key is correct and enabled, a password is sent to the transponder over the 125kHz AM signal through the ring antenna.
- When the transponders accepts the password, it releases the changing code, which it received from the EWS III module during the last start-up operation, to the EWS III module via the ring antenna.
- The EWS III module compares the changing code received from the transponder with the code stored in its memory and if they match the process is allowed to continue. The EWS III module looks at the other inputs for correct status (e.g. Code function not active, Transmission in P or N or clutch depressed, engine speed below specified RPM) and energizes the the internal relay to begin starter operation.
- As the starter begins to operate, the EWS III module sends the ISN to the DME and if verified as correct by the DME, drive away protection is cancelled and injection and ignition is enabled. The EWS III module also sends a new changing code to the key transponder through the ring antenna.

## **Replacement Procedures**

### **Keys**

Up to 6 additional keys may be ordered as replacement keys. The EWS III (3.2) module is codeable for only 10 keys (4 delivered with vehicle and 6 replacement). The keys are mechanically matched to the vehicle with the lock tumblers and electronically matched to the EWS III (3.2) through unalterable coding.

## **EWS III (3.2) Control Module**

Replacement EWS III (3.2) Control Modules must be ordered VIN specific. The EWS III modules contain the VIN and coding from the factory to recognize the key codes. Use of EWS III modules from other vehicles will result in the keys not being recognized.

The EWS III (3.2) control module stores the ZCS coding and must be coded at time of installation. The module must be aligned with the DME so that it stores the correct ISN. There is no limit to the number of times the ISN may be changed in the EWS III module.

## **DME Control Module**

DME Control Modules are “off the shelf” parts requiring programming during installation. The ISN of the DME is not changeable and must be transferred to the EWS III (3.2) module.

## **Key Activation**

Keys that are lost or stolen may be deactivated or made to not operate the starter functions. The SERVICE FUNCTIONS of the DISplus or MoDic for EWS III (3.2) contains a “Bar/Release Code” function that activates and deactivates keys of the EWS III (3.2). Any key may be “Barred” except the key in the ignition at the time of deactivation. The lost or stolen key can be identified by the identification of the remaining keys.

There is no limit to the number of times a key can be activated/deactivated.

## EWS III (3.3)

EWS III (3.3) is installed in the **1998 E38 from 5/97** production, in the **1998 E39 from 9/97** production, in the **E46** beginning of production, in the **E52** and **E53 beginning of production**.

### Purpose of the System

The purpose of the EWS III (3.3) system is to add greater theft protection by providing a higher level of sophistication than previous systems. The new “Rolling Code” provides an additional theft deterrent through a changing of the ISN everytime the vehicle enters the start sequence.

Components changed in the EWS III (3.3) system include:

- EWS III (3.3) Control Module.
- DME Control Module.
- Transmission Range Selection Input.

### System Components

#### EWS III (3.3) Control Module

The EWS III (3.3) Control Module uses the same 13 pin connector as EWS III (3.2) but functions differently. The EWS III (3.3) module has a “Rolling Code” ISN assigned to it during manufacture. The “Rolling Code” is burned into the module and cannot be overwritten by ZCS Coding or DME alignment procedures.

The “Rolling Code” is a one way signal from the EWS III (3.3) control module to the DME and is similar in operation to the data exchange between the EWS control module and the key transponder.

The “Rolling Code” will be different each time the start operation is begun. The “Codes” are taken from the “Rolling Code Table” which is assigned at the factory to the EWS III (3.3) control module and the DME.

#### Workshop Hint:

While it is possible to initialize a key to another vehicle to check for remote operation, use caution. **All keys for Both** vehicles must be available. The initializing process, causes loss of operation of keys previously initialized. All keys must be initialized at the same time.

UNIQUE ROLLING CODE TABLE ASSIGNED TO A MATED PAIR (EWS-DME) DURING FACTORY CODING PROCEDURE In: TABLE # XYZ		<b>EWS III (3.3)</b>
• <b>STATUS - NEW/USED</b>		
• <b>TABLE XYZ</b>		
1	101000100100101	
2	011010010100101	
3	000101010001010	
4	001001010111010	
ETC.	011101110110101	
<b>START PROCEDURE:</b>		
• <b>CALCULATE STORED CODE FROM LAST KEY OFF CONDITION AND SEND ANSWER TO DME</b>		

## **DME Control Module**

The DME Control Module has changed in that it is not the source of the ISN but now only stores the “Rolling Code”. It compares the “Codes” to those sent to it by the EWS III (3.3) control module. The “Rolling Code Table” assigned to the DME must match the table in the EWS III (3.3) module. The “Rolling Code Table is “burned” into the DME during the programming of the DME and cannot be change once “burned”.

## **Transmission Range Selection Input**

With the introduction of the SKE type connectors on Transmission Control Modules the direct input from the Transmission Range Selector Switch is eliminated. The input for range selection is now received from the AGS Control Module.

On manual transmission vehicles clutch status is input directly into the DME.

## **Principle of Operation**

The starting sequence of the EWS III (3.3) is as follows:

(Same as EWS III (3.2)

- The key is inserted into the lock cylinder and switched “ON”. The EWS III (3.3) control module is powered through KL R and sends a 125kHz AM signal to the ring antenna. The AM signal induces voltage in the key coil and powers up the transponder.
- Powered up, the key transponder sends the key identification code to the EWS III (3.3) module. The EWS III (3.3) module verifies the key identification code and checks to see if the key is enabled. If the key is correct and enabled, a password is sent to the transponder over the 125kHz AM signal through the ring antenna.
- When the transponders accepts the password, it releases the changing code which it received from the EWS III (3.3) module during the last start-up operation to the EWS III (3.3) module via the ring antenna.
- The EWS III (3.3) module compares the changing code received from the transponder with the code stored in its memory and if they match the process is allowed to continue. The EWS III (3.3) module looks at the other inputs for correct status (e.g. Code function not active, Transmission in P or N or clutch depressed, engine speed below specified RPM) and energizes the the internal relay to begin starter operation.

## New to EWS III (3.3)

- While energizing the internal starter relay, the EWS III (3.3) module calculates a stored code from the “Rolling Code Table” and sends the calculated results to the DME.
- On receipt of the “Rolling Code” from the EWS III (3.3) the DME calculates it’s own stored code and compares its results with the code it received from the EWS III (3.3).

*If the “Codes” match* the drive away protection is released and injection and ignition are enabled and the engine starts.

*If the “Codes” do **NOT** match*, the DME “rolls forward” to the next code according to the “Rolling Code Table” and makes the same calculations. The DME continues this “forward roll” up to a maximum of 200 times or until a match is found. Failure to find a match will result in the engine cranking but not starting.

- When the ignition is switched off and no engine RPM is present in both the DME and the EWS III (3.3) control module each module will automatically “roll forward” to the next predetermined code based on the “Rolling Code Table”. This new code is used for the next starting sequence.

### Workshop Hint:

If during diagnosis the key is switched on while the DME or EWS modules are “**Disconnected**”, the alignment procedure will need to be carried out. The “**Alignment**” procedure may be carried out an unlimited number of times.

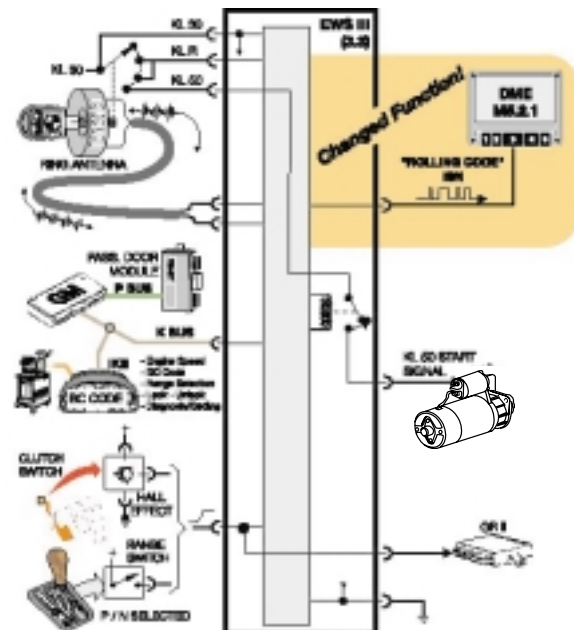
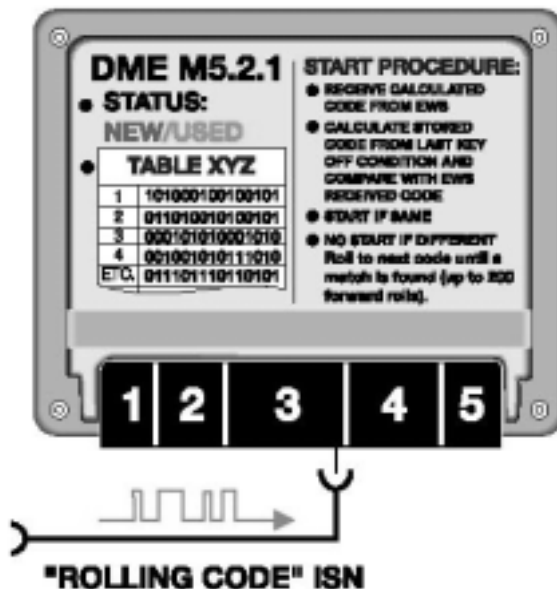

# Replacement Procedures

## Keys

Up to 6 additional keys may be ordered as replacement keys. The EWS II control module is codeable for only 10 keys (4 delivered with vehicle and 6 replacement).

## EWS III (3.3) Control Module

Replacement EWS III (3.3) Control Modules are ordered VIN specific. The module is received with the same “Rolling Code Table” as the original module. Once ZCS coded, the DISplus software “resets” the current rolling code in the DME back to “Rolling Code” #1, providing synchronization of both modules.

## DME Control Modules

Replacement DME Control Modules are “off the shelf” and must be programmed for the specific vehicle. After programming the DISplus software informs the EWS III (3.3) control module that a new DME has been installed. The next time the ignition is switched on, the EWS III (3.3) module will send the entire “Rolling Code Table” to the DME and reset it to “Rolling Code” #1.

**The DME will automatically burn the “Rolling Code Table” into its memory.** Once the table has been burned into the DME memory it can **NOT** be changed. For this reason once a DME is “Married” to the vehicle it will not work in any other vehicle.

Under certain condition “Alignment” of the DME and EWS III (3.3) modules may still be necessary. The alignment procedure only resets the code table to code #1 it does not change the “Rolling Code Table”.

## Key Activation

Keys that are lost or stolen may be deactivated or made to not operate the starter functions. The SERVICE FUNCTIONS of the DISplus or MoDic for EWS III (3.3) contains a “bar/release code” function that activates and deactivates keys of the EWS III (3.3). Any key may be “Barred” except the key in the ignition at the time of deactivation. The lost or stolen key can be identified by the identification of the remaining keys.

There is no limit to the number of times a key can be activated/deactivated.

### Workshop Hint:

While checking key operation, don't forget to wait 10 seconds before inserting the next key.

You can not **BAR** the key in the ignition.

### Workshop Hint:

A dead key battery does not affect vehicle starting.

Keys without replaceable batteries are not charged if the ignition is in the KLO (Off) position.

## **EWS III D**

EWS III D is installed on **E36/7 beginning of production 99 Model Year**. The system does not have a K-Bus input.

### **Purpose of the System**

The purpose of the EWS III D system is to provide the highest level of drive away protection available to vehicles without a K-Bus. The input side of the control module functions the same as an EWS II (no bus inputs) system with the exception of an integrated EWS module and transmitter/receiver module. The output side functions similar to an EWS III (3.3) system with “Rolling codes”. The EWS III D control module is on the D-Bus for diagnostics.

Individual component inputs and system operation is the same as the mentioned previous systems.

### **Replacement Procedures**

#### **Keys**

Up to 6 additional keys may be ordered as replacement keys. The EWS III D control module is codeable for only 10 keys (4 delivered with vehicle and 6 replacement).

#### **EWS III D Control Module**

Replacement EWS III D Control Modules are ordered VIN specific. The module is received with the same “Rolling Code Table” as the original module. Once ZCS codes, the DISplus software “resets” the current rolling code in the DME back to “Rolling Code” #1, providing synchronization of both modules.

#### **DME Control Modules**

Replacement DME Control Modules are “off the shelf” and must be programmed for the specific vehicle. After programming the DISplus software informs the EWS III D control module that a new DME has been installed. The next time the ignition is switched on, the EWS III D module will send the entire “Rolling Code Table” to the DME and reset it to “Rolling Code” #1.

**The DME will automatically burn the “Rolling Code Table” into its memory.** Once the table has been burned into the DME memory it can **NOT** be changed. For this reason once a DME is “Married” to the vehicle it will not work in any other vehicle.

Under certain condition “Alignment” of the DME and EWS III D modules may still be necessary. The alignment procedure only resets the code table to code #1 it does not change the “Rolling Code Table”.

## Key Activation

Keys that are lost or stolen may be deactivated or made to not operate the starter functions. The SERVICE FUNCTIONS of the DISplus or MoDic for EWS III D contains a “bar/release code” function that activates and deactivates keys of the EWS III D. Any key may be “Barred” except the key in the ignition at the time of deactivation. The lost or stolen key can be identified by the identification of the remaining keys.

There is no limit to the number of times a key can be activated/deactivated.

## Pin Assignments EWS III D

8510130

Pin 1	Terminal 31
Pin 2	Terminal 30
Pin 3	P/N Input From The Automatic Transmission
Pin 4	Diagnostic-Bus
Pin 5	Engine Speed
Pin 6	BC Code Input
Pin 7	Starter Output
Pin 8	Ignition Starter Switch Input
Pin 9	Terminal R
Pin 10	Toroidal Coil
Pin 11	Toroidal Coil
Pin 12	Reserve
Pin 13	Locking States
Pin 14	Data Line To The DME
Pin 15	Unlock Car

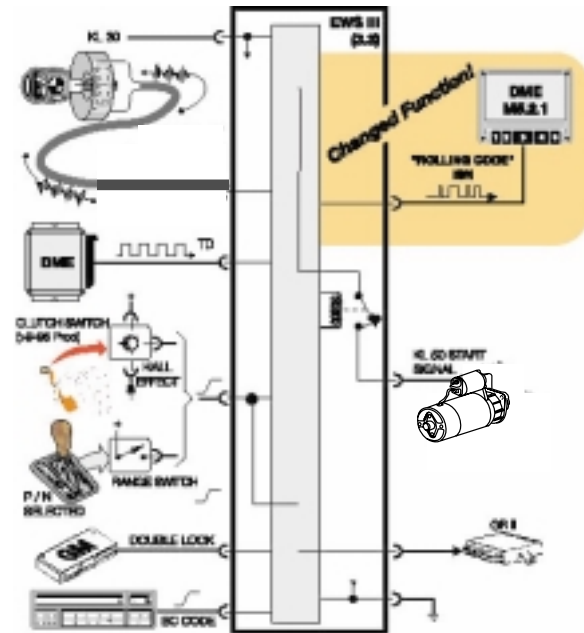

## Workshop Hint:

With E46 Style diagnostics, check the following status' in Diagnosis, Control Unit Functions, EWS:

- Starter Status:  
Park/Neutral, BC Code active, Engine Speed, Double lock status, Starter Enabled
- Key Status:  
Transmits, Changing code, Key I.D., Key number, Key Password, Key disabled
- DME Wire Status
- Selector lever/Clutch Status • Central Locking Status • Input Power • BC Code via K-Bus



# EWS

<b>System</b>	<b>Introduced</b>	<b>Model</b>	<b>Features</b>	<b>One Touch Starting</b>
Drive Away Protection	9/93 - 12/93	All	Injection/Ignition Disabled if car In Double lock	No
EWS I	1/94 - 1/95	All	Starter Immobilizer Injection/Ignition Disable	No
EWS II	1/95	E-36 To End of Production E36/7 To MY 1998 E-34 To End of Production E-38 To M.Y 1997 E-38 To 3/97 Production	Transponder Key  Starter Interlock  DME - EWS ISN Code	E38 Late MY 1997
EWS III 3.2	9/96	E 38 MY 97  E39 From 3/97 Production	Transponder Key  Starter Interlock  IDME-EWS ISN Code  K-Bus	Yes V-12 and V-8 Only
EWS III 3.3	5/97	E38 MY 1998 From 5/97 Production  E39 From 9/97 Production	Transponder Key  Starter Interlock  K-Bus DME-EWS Rolling Code	Yes V-12 and V-8 Only
EWS III D	MY 1999	Z3 Only	Transponder Key  Starter Interlock  DME-EWS Rolling Code	No